

# Q16

Rotary Potentiometer Switch



## Q16

Q16 is a particular application of the CS14 product family when robust and precise detents are required. This ACP patented design consists of a 16x15mm. rectangular shape external housing with a built-in detent mechanism, fitted on a CS14 V potentiometer.

The standard configuration has 16 detents evenly distributed along its 360° endless rotation, and allows to choose between 4 different detent torque values, from 3 Ncm to 6 Ncm to provide different degrees of softer or harder feeling.

The linear characteristics and materials of the CS14 core potentiometer, combined with the detent mechanism, guarantee at least 10.000 turns and no voltage overlapping between contiguous positions.

The rotor design allows a thru shaft to be inserted into the rotor from either top or below side. A Poka-Yoke feature incorporated in the rotor avoids shaft misplacement.

This Rotary Potentiometer Switch is the ideal alternative to Absolute Encoders and Rotary Switches for control applications like Program Selector Switches in White Goods: Washing Machines, Dishwashers, Dryers, Electrical Ovens etc., Controls in other Appliances like Ranges, Microwave Ovens, Kitchen Robots, etc., and HVAC in Automotive: Air Flow Distribution Switch, Temperature Setting and Fan Speed Selection.

Ingress Protection rating type is IP54 and plastic materials can be self-extinguishable according to UL 94V0 whenever required.

# Q16 HOW TO ORDER

EXAMPLE: Q16RV15 10KA3030 LV10 16DT 3N PDT1

## Standard features

Series	Rotor	Model	Packaging	Ohm value	Taper	Tolerance	Life	N° Detents	Det.torque.	Terminals	Flammability	Position
1	2	3	4	5	6	7	8	9	10	11	12	13
Q16	R	V15		10K	A	3030	LV10	16DT	3N			PDT1

## Standard configuration:

## Q16

Dimensions:	16x15mm
Protection:	IP 54. On request: Self extinguishable, to meet UL 94 V0
Core potentiometer:	CS14
Packaging:	Bulk
Wiper position:	Detent 1 (PDT1)
Terminals:	Straight
Marking:	Resistive value marked on housing. Others on request.

### 1 - Series

■ Q16

### 2 - Rotors

R Standard. (Others under study).

### 3 - Model and pitch

V15 Standard. VSMD under study.

### 4 - Packaging

Bulk (blank)...<sup>(1)</sup>

<sup>(1)</sup> Products supplied bulk packed in bags, unless otherwise specified.

### 5 - Resistive value

100Ω	200Ω	220Ω	250Ω	470Ω	500Ω	1KΩ	10KΩ standard...	5MΩ
100	200	220	250	470	500	1K	10K	5M

### 6 - Taper

Lin - Linear A

Others under study. Code will be assigned case by case.

### 7 - Tolerance

100 Ω ≤ Rn ≤ 100KΩ:	100 KΩ < Rn ≤ 1MΩ:	1 MΩ < Rn ≤ 5MΩ:
±30%	±30%	+50%,-30%
3030	3030	5030

Special tolerances under request. Please check availability.

### 8 - Operating Life (Turns)

Standard (10.000 turns) (others on request).	LV10
Long life: LV + number of turns. (please inquire availability).	LVXXX: ex: LV20

### 9 - Numbers of detents

Standard: 16 detents.	16DT
Other configurations under study	

### 10 - Detent torque

Standard: 3 Ncm	3N
Others available 4Ncm, 5Ncm, 6Ncm	4N, 5N, 6N

### 11 - Terminals

By default, terminals are always straight	(leave blank)
SNAP IN P	SNP
Steel Terminals	SH

### 12 - Flammability

Standard: Non self extinguishable.	(leave blank)
All housings and rotors self extinguishable according to UL 94 V0.	V0
Only Q16 housing and rotor self extinguishable V0	Q-V0

### 13 - Delivery position

Standard, position at detent 1	PDT1
Position at detent. XX= (position number)	PDTXX

### Special marking

Special marking	GRE
-----------------	-----

## Rotor

R is the standard rotor for Q16. Other options can be made under study.

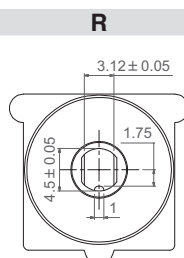

This drawing shows the rotor at 50% position in order to better depict the dimensions and tolerances, it is not a valid delivery option of the 16 position version.

V15 is the standard model.

V15

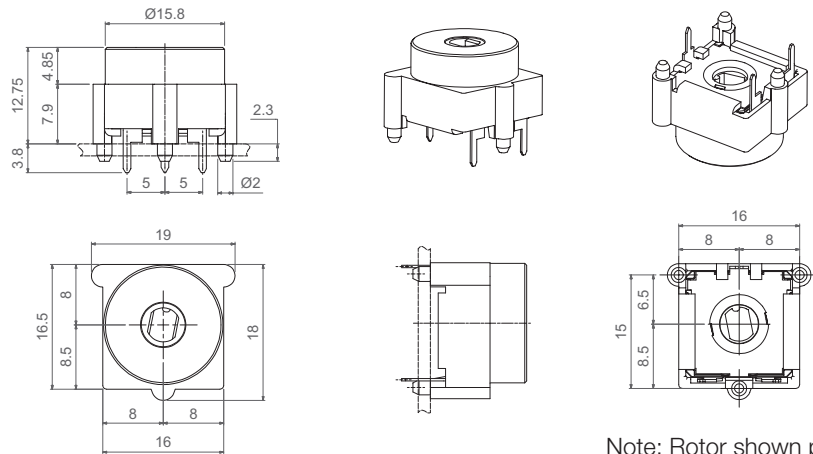

Note: Rotor shown positioned at detent 1 (PDT1)

Tapers

The CS14 core potentiometer has a linear taper that provides the voltage ratios indicated at each detent shown in the graph. Non overlapping voltage between contiguous positions is guaranteed.

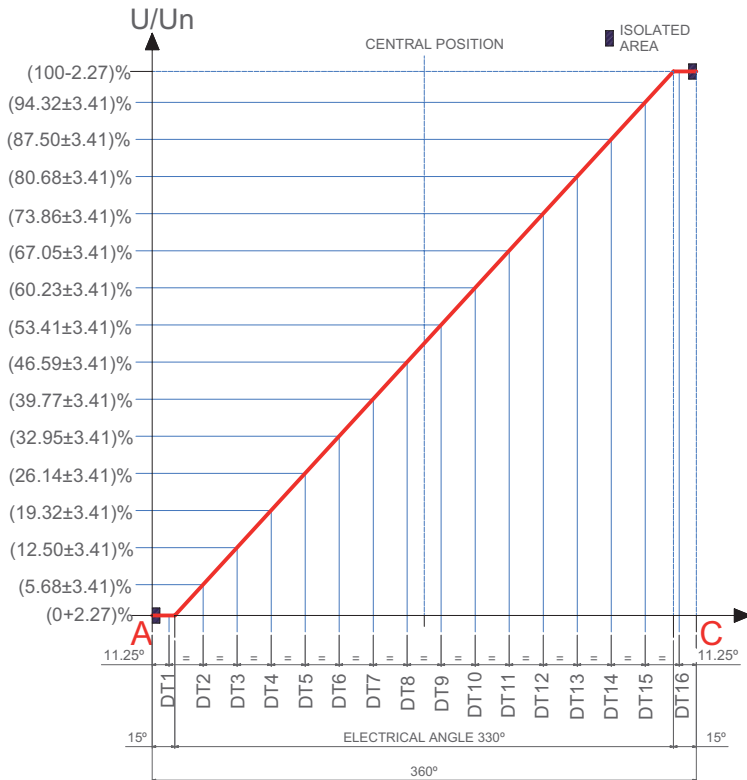

DETENT	VALUE
1	(0+2.27)% Un
2	(5.68±3.41)% Un
3	(12.50±3.41)% Un
4	(19.32±3.41)% Un
5	(26.14±3.41)% Un
6	(32.95±3.41)% Un
7	(39.77±3.41)% Un
8	(46.59±3.41)% Un
9	(53.41±3.41)% Un
10	(60.23±3.41)% Un
11	(67.05±3.41)% Un
12	(73.86±3.41)% Un
13	(80.68±3.41)% Un
14	(87.50±3.41)% Un
15	(94.32±3.41)% Un
16	(100-2.27)% Un

Detents/ Torque

Conceived specifically for control applications where robust click feeling is required along the full circumference. The Q16 incorporates an ACP patented design that provides 4 possible different torque levels: 3Ncm, 4Ncm, 5Ncm or 6Ncm, upon customer's choice, with a mechanical life of at least 10.000 turns

The standard number of detents is 16, all of them evenly spread along the 360° mechanical travel, an ideal configuration for 16 function selection in White Goods.

Tailor made configurations with different number of detents, preferably even numbers equally spread along the 360°, can be studied on request. Other mechanical life requirements are also possible upon study.

16DT

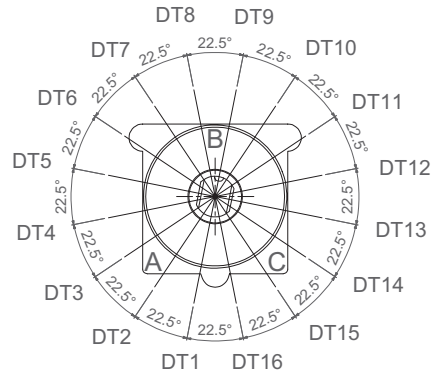
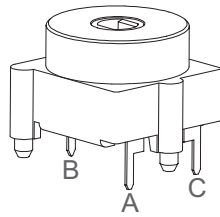

**Delivery Position**

Unless otherwise specified, the Q16 is delivered with the wiper on position 1 (PDT1).

**Shafts**

Shafts are sold separately. They can be inserted from either top or below side. Please consult ACP for studying special designs. Rotor inner dimensions shown for customer's own shaft design.

**Rotor inner dimensions**

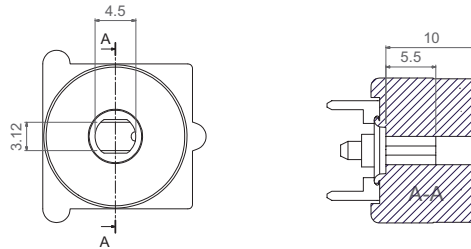

This drawing shows the rotor at 50% position in order to better depict the dimensions and tolerances, it is not a valid delivery option of the 16 position version.

**14301**

**14315**

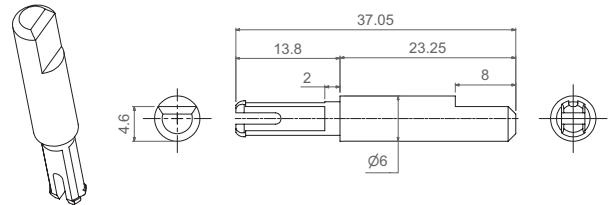
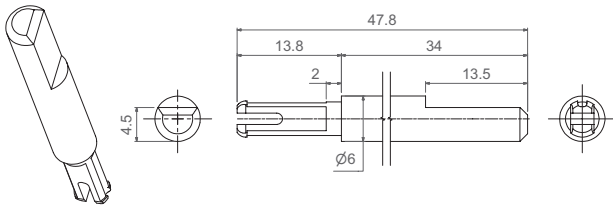

**Packaging**

**Bulk packaging:**

**Pieces per box (250 x 150 x 70)**

Q16 model

150

**Electrical Specifications**

(See CS14 Through Hole table on page 10).

**Mechanical Specifications**

**Test results**

Resistive element	Carbon
Angle of rotation (mechanical)	360°
Wiper standard delivery position	Detent 1 (PDT1)
Max. push/pull on rotor	50N
Wiper torque*	From 3N to 6N depending on customer choice.
Mechanical life	At least 10.000 turns.

Damp heat	(See CS14 table on page 10)
Temperature Coefficient	
Load life	
Mechanical life	
Storage (3 years)	